

ARTICLE NUMBER 1-025-143

TECHNICAL DRAWING

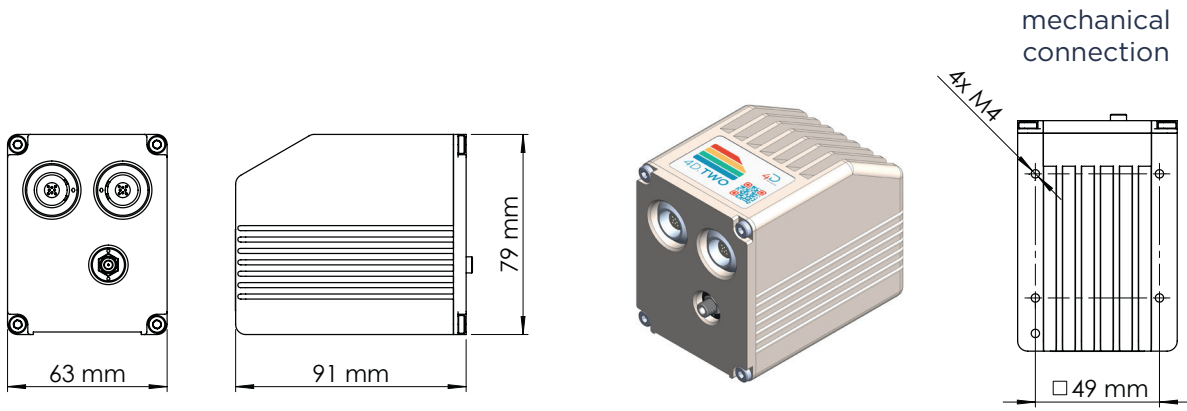

SPECTRAL RANGE

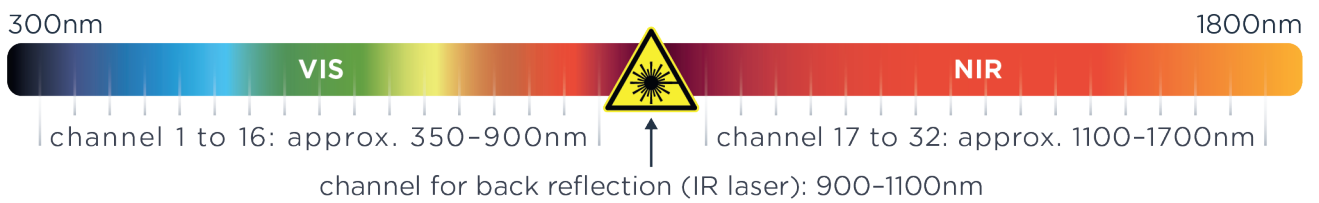

SENSOR TECHNOLOGY

VIS	Back reflection (IR laser)	NIR
350-900 nm spectrally resolved w/ 16 channels @6 kHz max.	900-1100 nm w/ 1 channel @100 kHz	1100-1700 nm spectrally resolved w/ 16 channels @6 kHz max.
350-900 nm integrated w/ 1 channel @100 kHz		1100-1700 nm integrated w/ 1 channel @100 kHz
position/orientation and acceleration		
temperature, relative humidity and air pressure		

SPECIFICATIONS

Dimensions w/o adapter and cable	LxWxH 91x63x79 mm
Weight	520 g
Recommended integration	laser processing head
Mechanical connection	4x M4 (49x49 mm)
Optical connection	optical fiber (SMA)
Electrical connection 1	ODU 8-pin PoE, communication
Electrical connection 2	ODU 8-pin I/O, 0-10 V analog in, 0-5 V analog out

+49 511 235 947 0
sales@4d-photonics.com

ACCESSORIES

Required	sensor cable 30m 4D.TWO
Required	optical fiber
Required	fiber coupler
Required	adapter (several solutions available and customized solutions on request)

PRODUCT VIEWS



+49 511 235 947 0
sales@4d-photonics.com